



67" French Bateau CoreAcryl Bathtub with Skirt

Available Options

1. Acrylic skirt
2. Acrylic skirt air jetted with no remote parts
3. Copper skirt
4. Copper skirt air jetted with no remote parts



MA Code Accepted

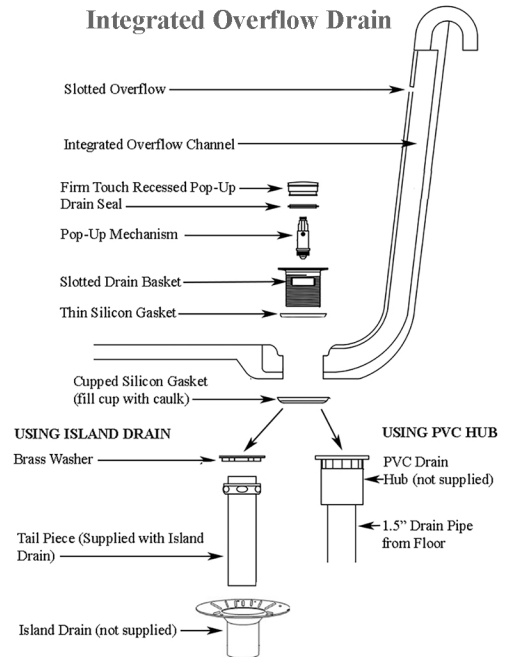
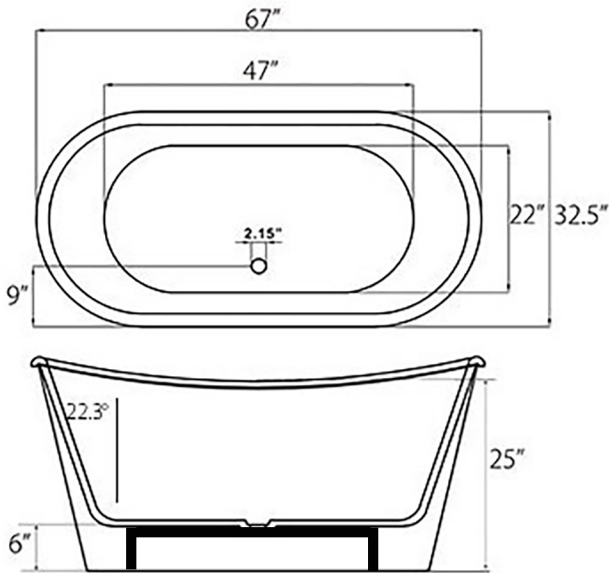

If air jetted, the air blower will be positioned in the space under the inner shell.

There will be 12 air jets on the floor of the tub.

There will be approved stop valves to prevent water flowing back to the blower.

The variable speed blower will be activated using a wireless, waterproof remote control.

If a seven color-choice chromotherapy light is included, there will be a dedicated button on the remote to activate and to change light colors.

The electrical plug can be positioned under the tub and connected to an easy to access remote 15amp -110v GFCI. Or, a hole can be drilled in the shell and connected to a wall GFCI. We suggest using a secure cable gland if going through the tub shell.

Inner shell is made from 3/4" thick double skin CoreAcryl acrylic

Outer shell options are reinforced acrylic and 1.6mm thick solid copper.

Outer shell finishes include white, any color painted, various leafed, leafed and aged, polished, hammered and aged patina copper.

The inner shell of the tub is supported on a steel frame that is connected to the outer shell. The shells can be easily separated for moving purposes if required.

The frame under the inner shell has four adjustable height legs for uneven floors.

The tub is connected to the floor by attaching industrial strength Velcro (supplied) to the adjustable foot pads.

Recommended drain connections are PVC hub or Island floor drain with tail piece

Dimensions may vary by up to 1/2"

bathsofdistinction.com